

Edgeless Cove

KNIFE EDGE EXTRUSION

PROJECT _____

TYPE _____

- / 5" edgeless single-channel extrusion for one side of architectural cove
- / 1 extrusion required per cove edge
- / Each run of extrusion includes a joiner kit.
- / Plaster-in precision knife edge
- / Extruded aluminum construction
- / Custom lengths can be cut in the field
- / Field-paintable

- / Designed for use with Solais fixtures
- / Dry location rating
- / 1 year warranty

- / Consult factory for additional end caps and joiner kits



/ Outside Corner 90°

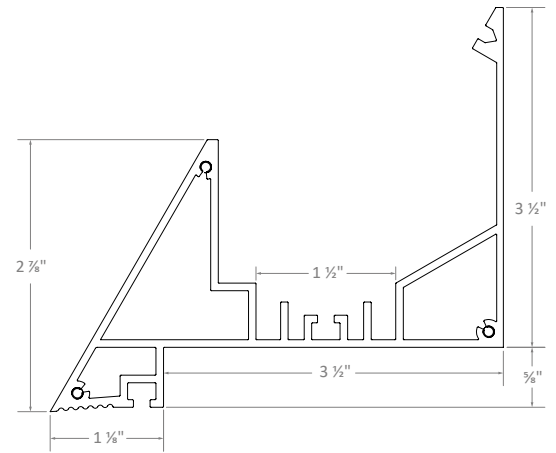
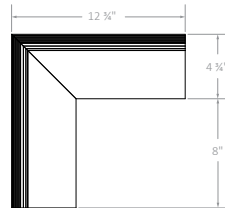
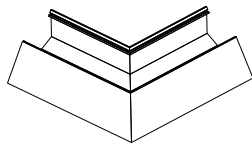

/ Inside Corner 90°

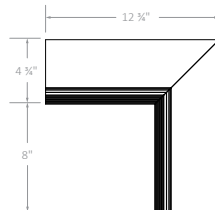
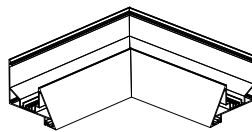
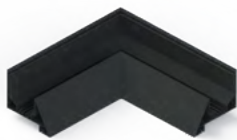

/ End Cap

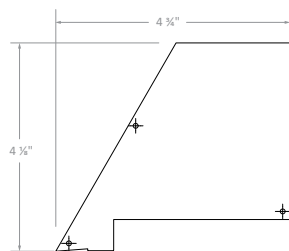

Ordering Information

Example: EC5/08/o90

Type	Length	Options
EC5	01 - 1' 02 - 2' 03 - 3' 04 - 4' 06 - 6' 08 - 8'	o90 - Outside 90° Corner* i90 - Inside 90° Corner*

Ordering Information

Example: EC5/L

Type	End Cap
EC5	L - Left R - Right

*Consult factory for lead time and availability

Edgeless Cove KNIFE EDGE EXTRUSION

PROJECT

TYPE

